

RAPID Fittings Stainless Steel AISI 316L (1.4404) with Union Nut Nickel-Plated Brass (Push-on)

Rapid version with Union nut (nickel-plated brass)

Operating pressure: Technical vacuum up to maximum pressure as stated in the respective specification table under PN.

Temperature range: -40 °C to +140 °C
(for restrictions see specification table)

Application

RAPID fittings are used with aggressive gaseous and liquid media, where elastomer seals are not resistant. With guide cone and Union nut these fittings are particularly suited to very harsh operating conditions.

CHARACTERISTICS
BODY MATERIAL / SUITABILITY

Stainless steel AISI 316L	corresponds to stainless steel 1.4404 . Suitable for many aggressive media. The FKM seal ring is FDA-compliant and can be used in the food and pharmaceutical industries.
Union nut: Nickel-plated brass	CuZn39Pb3, galvanically nickel-plated. Union nut not in contact with the medium.
Other materials	see relevant products
Approval	NSF/ANSI 169

TUBE

Outside diameter D [mm] Inside diameter d [mm]	6/4 8/6 10/8	12/10
Permitted tolerance outside D	±0.1	±0.15
Permitted tolerance inside d	±0.1	±0.15
Permitted wall thickness tolerance	±0.1 With very soft tubes, for example PVC tubes, variations in the outside diameter or wall thickness of up to + 5/10 are allowable. In case of doubt please ask.	
Permitted grades	Polyamide (PA), polyurethane (PU), polyethylene (PE), fabric reinforced PVC, fluoropolymer (FEP) (PFA)	

THREAD

External thread	"G" cylindrical thread: Whitworth pipe thread DIN ISO 228-1 G 1/8 to G 1/2
External thread	"R" Conical thread: Whitworth pipe thread DIN 2999-1 and ISO 7/1 R 1/8 to R 1/2. Dimensions constructed so there can be pairing with internal thread according to DIN ISO 228-1.

OPERATING PRESSURE / TEMPERATURE

Metal version	<table border="1"> <tr> <td>PN</td> <td>T_{min} -40 °C</td> <td rowspan="2">Means that the fitting can be used up to the given nominal pressure PN within the specified temperature range "T". Allowable operating pressure and operating temperature of pipe/tube must be observed!</td> </tr> <tr> <td>25</td> <td>T_{max} +140 °C</td> </tr> </table>	PN	T _{min} -40 °C	Means that the fitting can be used up to the given nominal pressure PN within the specified temperature range "T". Allowable operating pressure and operating temperature of pipe/tube must be observed!	25	T _{max} +140 °C
PN	T _{min} -40 °C	Means that the fitting can be used up to the given nominal pressure PN within the specified temperature range "T". Allowable operating pressure and operating temperature of pipe/tube must be observed!				
25	T _{max} +140 °C					

THREAD SEAL

Cylindrical threaded nipple	Seal with sealing rings made of copper, fibre, aluminium, polyamide or hard PVC. Seal with chambered O-ring (FDA-compliant) on request
Conical threaded nipple	Seal with Teflon tape winding (FDA-compliant) on request

Straight, 90° elbow and T-adaptors, male	<table border="1"> <tr> <td>not suitable for rotating or oscill. movements</td> <td>Some types of fittings are 360°-swivelling to facilitate adjustment during assembly.</td> </tr> </table>	not suitable for rotating or oscill. movements	Some types of fittings are 360°-swivelling to facilitate adjustment during assembly.
not suitable for rotating or oscill. movements	Some types of fittings are 360°-swivelling to facilitate adjustment during assembly.		

Straight Adaptor - Male

Price group	13	PN 25	T _{min} -40 °C T _{max} +140 °C	Cylindrical thread		Union nut: Nickel-plated brass	Stainless steel AISI 316L
-------------	-----------	-------	---	--------------------	--	--------------------------------	---------------------------

for tube D/d	G	i	L1*	S1	S	Weight in [g]	Type	Order number	Price
6/4	G 1/8	8	18.5	10	13	13.2	151X4-6/4M-1/8	360064	o. r.
6/4	G 1/4	10	19	10	17	22.8	151X4-6/4M-1/4	360065	o. r.
8/6	G 1/8	8	18.5	12	13	15.9	151X4-8/6M-1/8	360070	o. r.
8/6	G 1/4	10	19	12	17	25	151X4-8/6M-1/4	360071	o. r.
10/8	G 1/8	8	20	13	14	21.2	151X4-10/8M-1/8	360079	o. r.
10/8	G 1/4	10	20.5	13	17	26.2	151X4-10/8M-1/4	360080	o. r.
10/8	G 3/8	10	20.5	13	19	34.4	151X4-10/8M-3/8	360081	o. r.
12/10	G 1/4	10	22	15	17	27.9	151X4-12/10M-1/4	360092	o. r.
12/10	G 3/8	10	22	15	19	36.1	151X4-12/10M-3/8	360093	o. r.
12/10	G 1/2	12	22.5	15	24**	52.9	151X4-12/10M-1/2	360094	o. r.

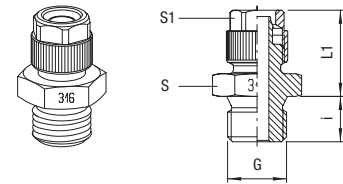
Illustration

Straight Adaptor - Male

Price group	13	PN 25	T _{min} -40 °C T _{max} +140 °C	Conical thread		Union nut: Nickel-plated brass	Stainless steel AISI 316L
-------------	-----------	-------	---	----------------	--	--------------------------------	---------------------------

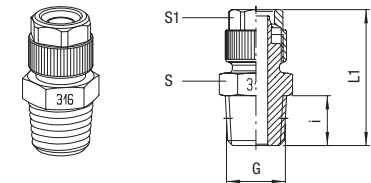
for tube D/d	G	i	L1*	S1	S	Weight in [g]	Type	Order number	Price
6/4	R 1/8	7.5	26	10	12	12	151X4-6/4M-1/8K	360464	o. r.
6/4	R 1/4	11	30	10	14	19	151X4-6/4M-1/4K	360465	o. r.
8/6	R 1/8	7.5	26	12	12	14.6	151X4-8/6M-1/8K	360470	o. r.
8/6	R 1/4	11	30	12	14	22	151X4-8/6M-1/4K	360471	o. r.
10/8	R 1/8	7.5	27.5	13	14	21.4	151X4-10/8M-1/8K	360479	o. r.
10/8	R 1/4	11	31.5	13	14	24	151X4-10/8M-1/4K	360480	o. r.
10/8	R 3/8	11.5	32	13	17	33.2	151X4-10/8M-3/8K	360481	o. r.
12/10	R 3/8	11.5	33.5	15	17	35.2	151X4-12/10M-3/8K	360493	o. r.
12/10	R 1/2	14	36.5	15	22	on req.	151X4-12/10M-1/2K	360494	o. r.

Illustration

90° Elbow Adaptor - Male

Price group	13	PN 25	T _{min} -40 °C T _{max} +140 °C	Conical thread		Union nut: Nickel-plated brass	Stainless steel AISI 316L
-------------	-----------	-------	---	----------------	--	--------------------------------	---------------------------

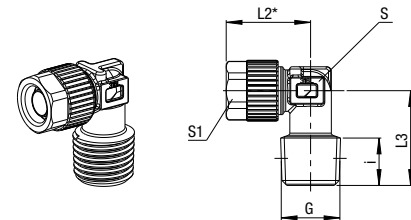
for tube D/d	G	i	L2*	L3	S1	S	Weight in [g]	Type	Order number	Price
6/4	R 1/8	7.5	17.5	16.9	10	8	13.5	150X4M-6/4M-1/8K	361321	o. r.
6/4	R 1/4	10.5	17.5	19.9	10	9	18.4	150X4M-6/4M-1/4K	361322	o. r.
8/6	R 1/8	7.5	18.5	18	12	9	16.9	150X4M-8/6M-1/8K	361323	o. r.
8/6	R 1/4	10.5	18.5	21	12	10	22.1	150X4M-8/6M-1/4K	361324	o. r.
8/6	R 3/8	10.8	26.5	24.5	12	13	39.4	150X4-8/6M-3/8K	361072	o. r.
10/8	R 1/8	9	24.5	18.5	13	10	29.5	150X4-10/8M-1/8K	361079	o. r.
10/8	R 1/4	10.5	24.5	21	13	10	24.5	150X4-10/8M-1/4K	361080	o. r.
10/8	R 3/8	10.8	27	24.5	13	13	39.6	150X4-10/8M-3/8K	361081	o. r.
12/10	R 3/8	11.5	29	25	15	13	42.2	150X4-12/10M-3/8K	361093	o. r.
12/10	R 1/2	14.2	30.5	29	15	17	58.5	150X4-12/10M-1/2K	361094	o. r.

Illustration

90° Elbow Adaptor - Male - Positionable

Price group	13	PN 16	T _{min} 0 °C T _{max} +140 °C	Cylindrical thread	Seal: FKM FDA-compliant	not suitable for rotating or oscill. movement		Union nut: Nickel-plated brass	Stainless steel AISI 316L
-------------	-----------	-------	---	--------------------	----------------------------	---	--	--------------------------------	---------------------------

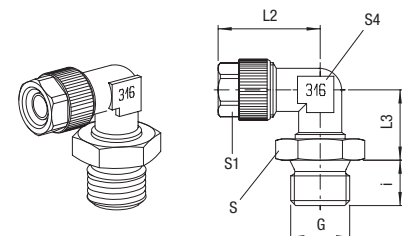
for tube D/d	G	i	L2*	L3	S1	S4	S	Weight in [g]	Type	Order number	Price
6/4	G 1/8	8	22.5	14	10	10	13	23.4	130X4-6/4M-1/8FF	361164	o. r.
6/4	G 1/4	10	22.5	14.5	10	10	17	26.8	130X4-6/4M-1/4FF	361165	o. r.
8/6	G 1/8	8	22.5	14	12	10	13	24	130X4-8/6M-1/8FF	361170	o. r.
8/6	G 1/4	10	22.5	14.5	12	10	17	28.2	130X4-8/6M-1/4FF	361171	o. r.
10/8	G 1/4	10	24	14.5	13	10	17	29.7	130X4-10/8M-1/4FF	361180	o. r.

Illustration

* approximate with fastened Union nut ** S24 = octagon

90° Elbow Adaptor - Male - Positionable

Price group	13	PN 16	T _{min} 0 °C T _{max} +140 °C	Conical thread	Seal: FKM FDA-compliant	not suitable for rotating or oscill. movement		Union nut: Nickel-plated brass	Stainless steel AISI 316L		
for tube D/d	G	i	L2*	L3	S1	S4	S	Weight in [g]	Type	Order number	Price
6/4	R 1/8	7.5	22.5	21.5	10	10	13	22.5	130X4-6/4M-1/8KFF	361264	o. r.
6/4	R 1/4	11	22.5	25.5	10	10	17	26.6	130X4-6/4M-1/4KFF	361265	o. r.
8/6	R 1/8	7.5	22.5	21.5	12	10	13	23.6	130X4-8/6M-1/8KFF	361270	o. r.
8/6	R 1/4	11	22.5	25.5	12	10	17	28.1	130X4-8/6M-1/4KFF	361271	o. r.
10/8	R 1/4	11	24	25.5	13	10	17	29.4	130X4-10/8M-1/4KFF	361280	o. r.

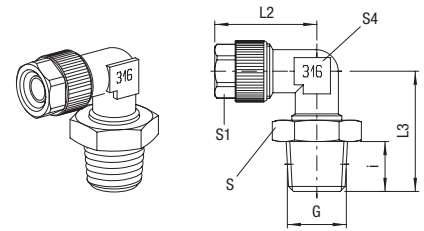
Illustration

T-Adaptor - Male

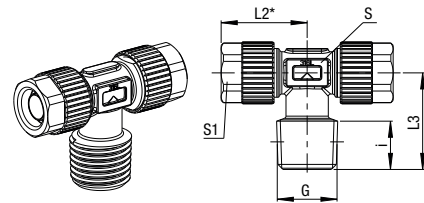
Price group	13	PN 25	T _{min} -40 °C T _{max} +140 °C	Conical thread				Union nut: Nickel-plated brass	Stainless steel AISI 316L	
for tube D/d	G	i	L2*	L3	S1	S	Weight in [g]	Type	Order number	Price
6/4	R 1/8	7.5	17.5	16.9	10	8	20.8	141X4M-6/4M-1/8K	361821	o. r.
6/4	R 1/4	10.5	17.5	19.9	10	9	25.7	141X4M-6/4M-1/4K	361822	o. r.
8/6	R 1/8	7.5	18.5	18	12	9	26	141X4M-8/6M-1/8K	361823	o. r.
8/6	R 1/4	10.5	18.5	21	12	10	31.4	141X4M-8/6M-1/4K	361824	o. r.
10/8	R 1/8	9	25	18.5	13	10	34.1	141X4-10/8M-1/8K	361479	o. r.
10/8	R 1/4	10.5	25	21	13	10	37.9	141X4-10/8M-1/4K	361480	o. r.
10/8	R 3/8	11.3	27	25	13	13	39.6	141X4-10/8M-3/8K	361481	o. r.
12/10	R 3/8	11.3	29	25	15	13	59.9	141X4-12/10M-3/8K	361493	o. r.
12/10	R 1/2	14.2	30.5	29	15	17	91	141X4-12/10M-1/2K	361494	o. r.

Illustration

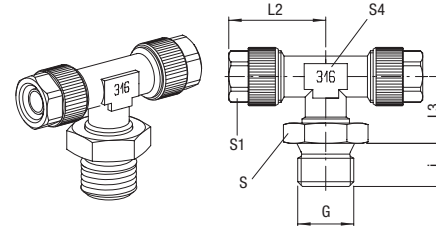
T-Adaptor - Male - Positionable

Price group	13	PN 16	T _{min} 0 °C T _{max} +140 °C	Cylindrical thread	Seal: FKM FDA-compliant	not suitable for rotating or oscill. movement		Union nut: Nickel-plated brass	Stainless steel AISI 316L		
for tube D/d	G	i	L2*	L3	S1	S4	S	Weight in [g]	Type	Order number	Price
6/4	G 1/8	8	22.5	14	10	10	13	32.3	121X4-6/4M-1/8FF	361564	o. r.
6/4	G 1/4	10	22.5	14.5	10	10	17	35.1	121X4-6/4M-1/4FF	361565	o. r.
8/6	G 1/8	8	22.5	14	12	10	13	34.2	121X4-8/6M-1/8FF	361570	o. r.
8/6	G 1/4	10	22.5	14.5	12	10	17	38.2	121X4-8/6M-1/4FF	361571	o. r.
10/8	G 1/4	10	24	14.5	13	10	17	41.5	121X4-10/8M-1/4FF	361580	o. r.

Illustration

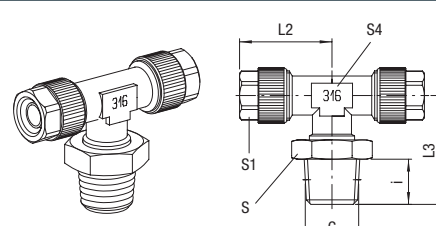
T-Adaptor - Male - Positionable

Price group	13	PN 16	T _{min} 0 °C T _{max} +140 °C	Conical thread	Seal: FKM FDA-compliant	not suitable for rotating or oscill. movement		Union nut: Nickel-plated brass	Stainless steel AISI 316L		
for tube D/d	G	i	L2*	L3	S1	S4	S	Weight in [g]	Type	Order number	Price
6/4	R 1/8	7.5	22.5	21.5	10	10	13	32.2	121X4-6/4M-1/8KFF	361664	o. r.
6/4	R 1/4	11	22.5	25.5	10	10	17	36.4	121X4-6/4M-1/4KFF	361665	o. r.
8/6	R 1/8	7.5	22.5	21.5	12	10	13	34.3	121X4-8/6M-1/8KFF	361670	o. r.
8/6	R 1/4	11	22.5	25.5	12	10	17	38.9	121X4-8/6M-1/4KFF	361671	o. r.
10/8	R 1/4	11	24	25.5	13	10	17	40.9	121X4-10/8M-1/4KFF	361680	o. r.

Illustration

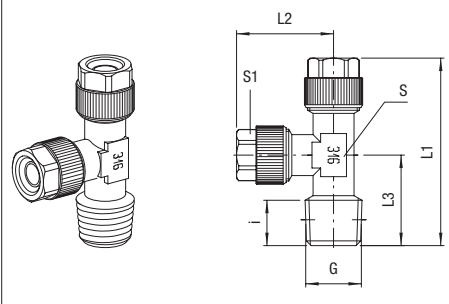
Side T-Adaptor - Male

Price group	13	PN 25	T _{min} -40 °C T _{max} +140 °C					Union nut: Nickel-plated brass	Stainless steel AISI 316L		
for tube D/d	G	i	L1*	L2*	L3	S1	S	Weight in [g]	Type	Order number	Price
6/4	R 1/8	9	41	22.5	18.5	10	10	26.8	142X4-6/4M-1/8K	361764	o. r.
6/4	R 1/4	10.5	43.5	22.5	21	10	10	29.5	142X4-6/4M-1/4K	361765	o. r.
8/6	R 1/8	9	41	22.5	18.5	12	10	28.9	142X4-8/6M-1/8K	361770	o. r.
8/6	R 1/4	10.5	43.5	22.5	21	12	10	31.6	142X4-8/6M-1/4K	361771	o. r.
10/8	R 1/8	9	43.5	25	18.5	13	10	on req.	142X4-10/8M-1/8K	361779	o. r.
10/8	R 1/4	10.5	46	25	21	13	10	on req.	142X4-10/8M-1/4K	361780	o. r.
10/8	R 3/8	11.5	52	27	25	13	13	on req.	142X4-10/8M-3/8K	361781	o. r.

Illustration

* approximate with fastened Union nut

90° Elbow Connector

 Price group **13** PN 25 $T_{min} -40\text{ °C}$ $T_{max} +140\text{ °C}$

Union nut: Nickel-plated brass

Stainless steel AISI 316L

for tube A D/d	for tube B D/d	L2*	S1	S	Weight in [g]	Type	Order number	Price
6/4	6/4	22.5	10	10	23.4	155X4-6/4M	362185	o. r.
8/6	8/6	22.5	12	10	24.6	155X4-8/6M	362187	o. r.
10/8	10/8	25	13	10	29.2	155X4-10/8M	362190	o. r.
12/10	12/10	29	15	13	on req.	155X4-12/10M	362194	o. r.

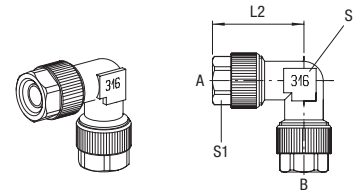
Illustration

T-Connector

 Price group **13** PN 25 $T_{min} -40\text{ °C}$ $T_{max} +140\text{ °C}$

Union nut: Nickel-plated brass

Stainless steel AISI 316L

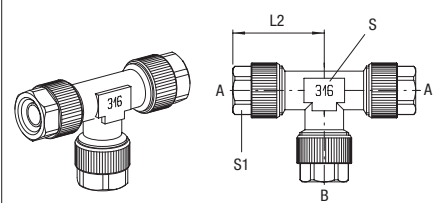
for tube A D/d	for tube B D/d	L2*	S1	S	Weight in [g]	Type	Order number	Price
6/4	6/4	22.5	10	10	31.7	154X4-6/4M	362385	o. r.
8/6	8/6	22.5	12	10	34.1	154X4-8/6M	362387	o. r.
10/8	10/8	25	13	10	42.7	154X4-10/8M	362390	o. r.
12/10	12/10	29	15	13	63.9	154X4-12/10M	362394	o. r.

Illustration

* approximate with fastened Union nut